

USER MANUAL



Thank you for choosing Better Bathrooms.
Please read this manual before installing your product
and keep for future reference.

better 
bathrooms

MRD5080P

EMPIRE500

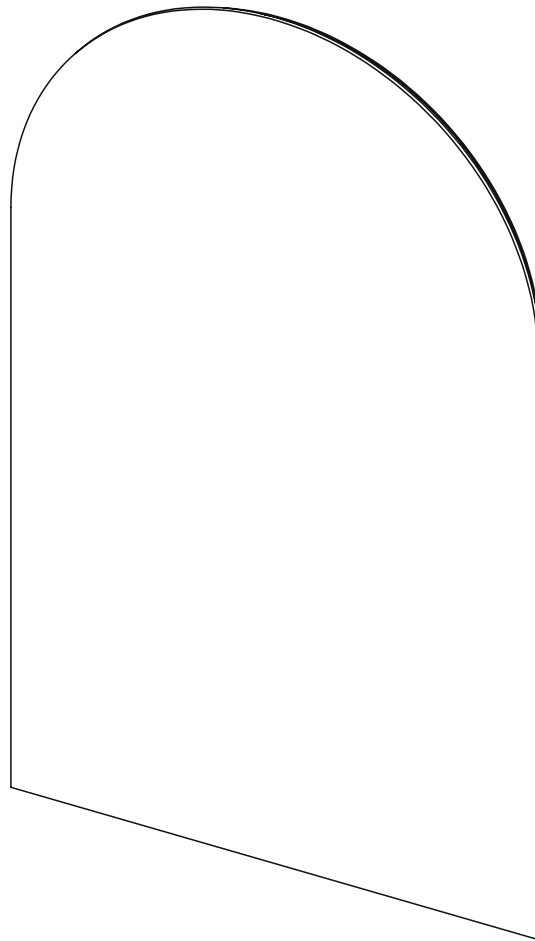

- Single-person assembly
- Tools required
- We always recommend using professional tradespeople to install your product

V0_11.15.23

Congratulations on your purchase

And welcome to our growing gang of savvy shoppers

We're on a mission to bring you extraordinary bathroom products, for less. From modern to traditional style ceramics, plus the gorgeous fixtures, fittings and furniture to match. So, you can fall in love with your space every single day.

As one of the UK's largest independent bathroom stores, we've received countless awards; including the National Business Awards UK, the Digital Entrepreneur Awards and being placed on The Sunday Times Fast Track 100.

We hope your new product goes above and beyond your expectations. However, should any problems occur, please:

- log in to your account and contact our customer services team via your self-serve portal – betterbathrooms.com/CustomerAccount/Login
- contact us via betterbathrooms.com/content/contact-us

Important information

- Please read these instructions thoroughly and retain for future reference
- Pressures should meet minimum stated on the website
- Pressures must be balanced for optimum performance
- Always check for pipes and cables before drilling

Wiring

All electrical equipment within a bathroom or shower room must be connected to a residual current device as per Part P of the Building Regulations. This product is manufactured to class I category and requires an earth connection.

Input Voltage: 220 - 240V ~ 50Hz





COLOUR CODING:

- L - Live = Brown
- Neutral = Blue
-  - Earth = Green & Yellow

Maintenance & Care

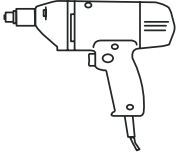
- To keep the finish of this product, wipe over with soft cloth periodically.
- Do not use harsh chemical solvents, this may dis-colour or damage the finish.

Tools Required (not supplied):

Drill + 8mm Drill Bit		Safety Goggles	
pencil		Screw Driver (Phillips No 2)	
Tape MEasure		Spirit Level	

COMPONENTS

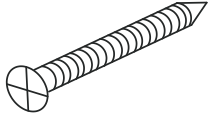
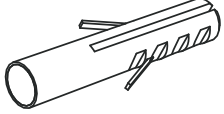
2 X Fixing Screws	
2 x Wall Plugs for solid wall only	

Installation procedure

1

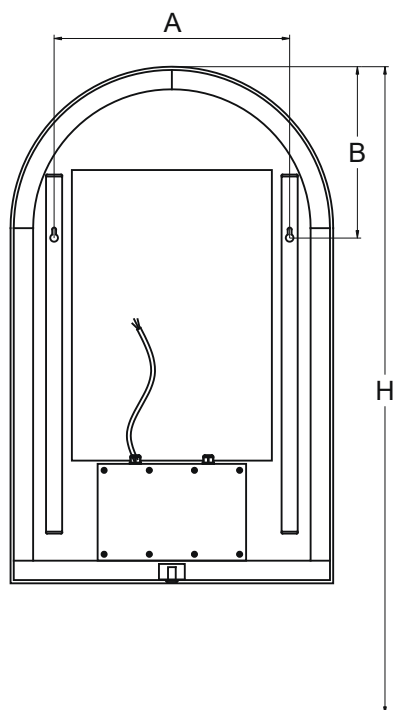

2

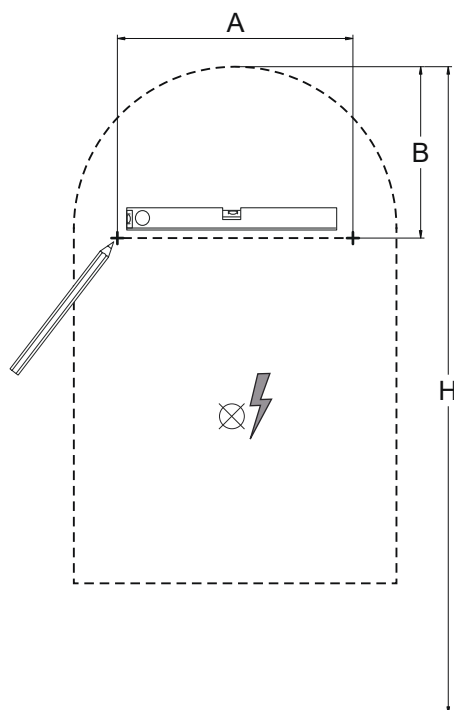

3

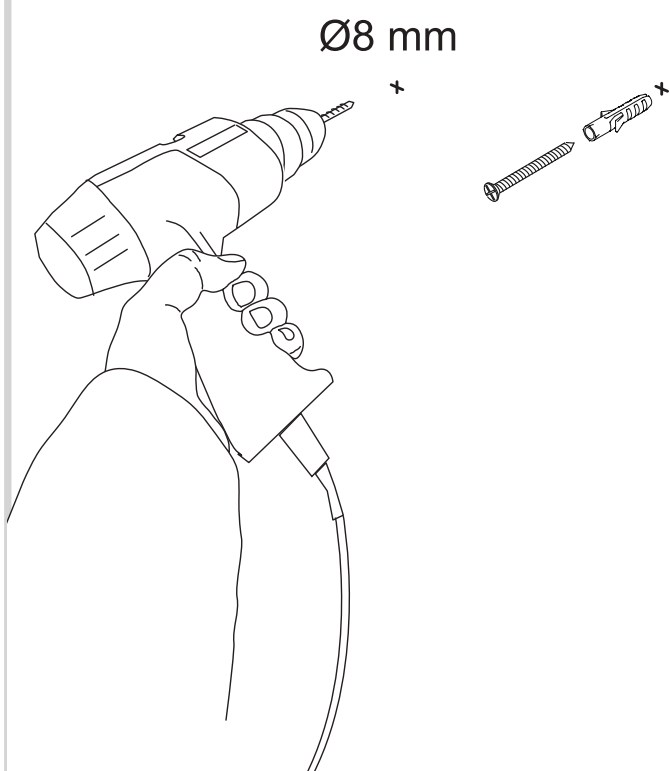

3

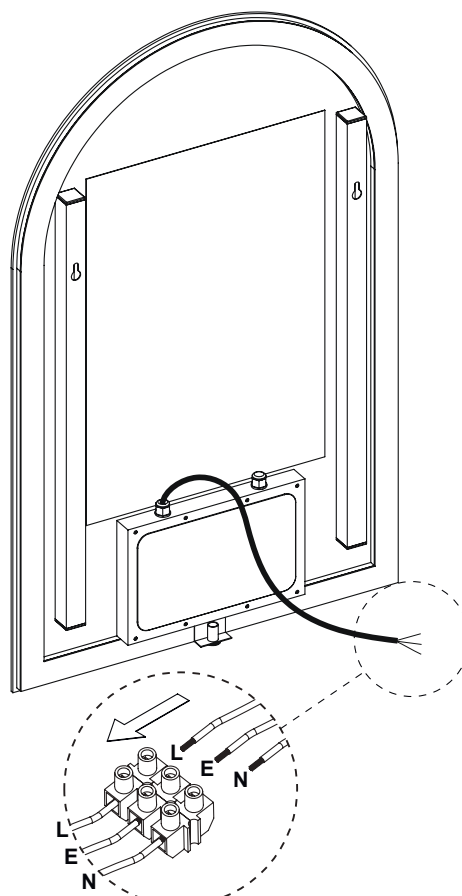

5

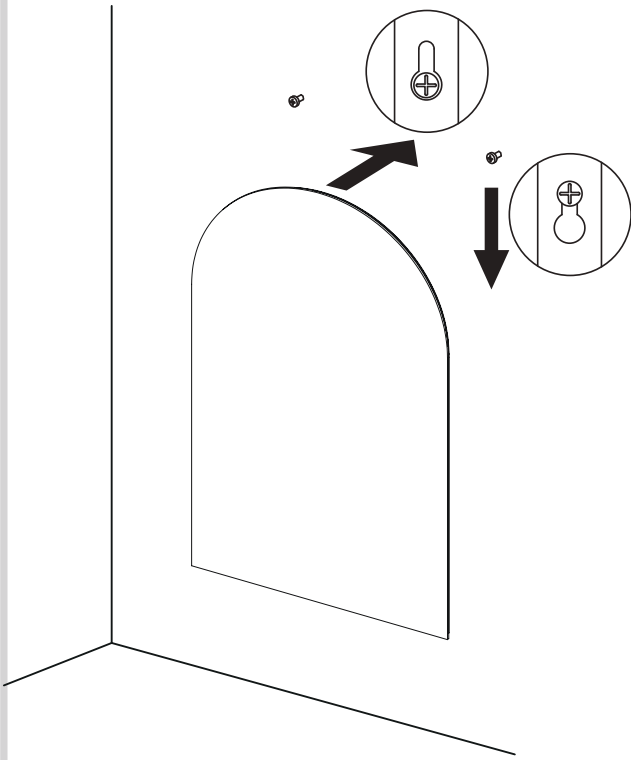

6

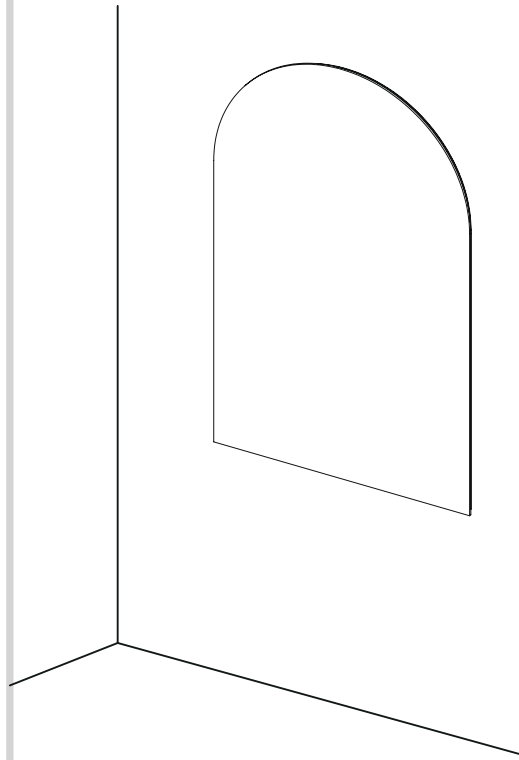

7

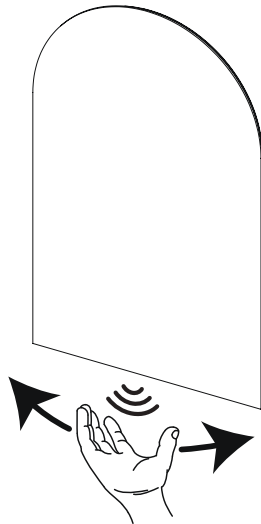

On/Off

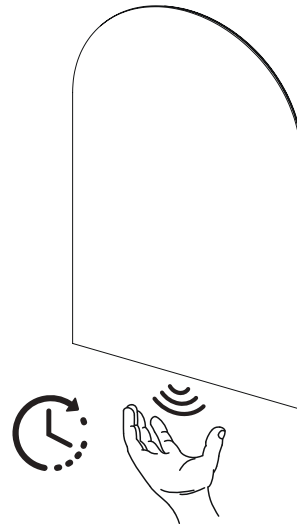

Keep your hand next to the IR sensor for several seconds to change the colour temperature

For more information

- visit betterbathrooms.com
- email customerservices@buyitdirect.co.uk
- call 0330 390 3062
- write to Trident Business Park, Neptune Way, Huddersfield, HD2 1UA

**better
bathrooms**

Part of the BuyItDirect Group